

- * INSTALLATION IS REQUIRED BY OTHERS.
- * ALL EDGES TO HAVE 1/4" RADIUS MIN.
- * MANUFACTURING TOLERANCE $\pm 1/4"$.
- * PRODUCT: QR-TS3622P
- * QUANTITY: _____
- * CONCRETE COLOR: _____
- * CONCRETE TEXTURE: _____
- * SEALER: STANDARD GLOSS SEALER
- * STD. 2" DIA. DRAIN HOLE
- * STD. COLOR & TEXTURE OPTIONS

APROX. WT. 585 Lbs.
 (CUSTOMER TO OFFLOAD IF OVER 8000 Lbs.)

Authorized Signature _____ Date _____
 By signing above or stamping this drawing "approved" or
 "no exception taken" authorization is given to Quick Crete
 to produce this drawing as shown within a 1/4" tolerance.

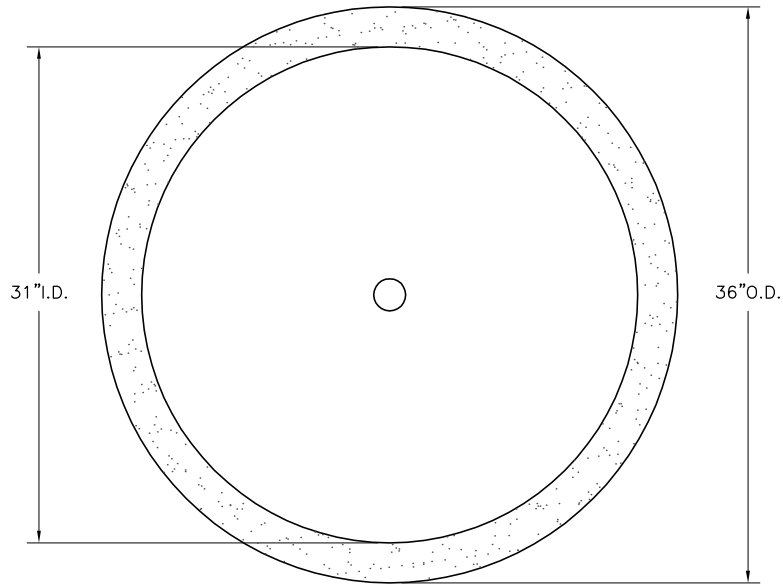

PLAN VIEW

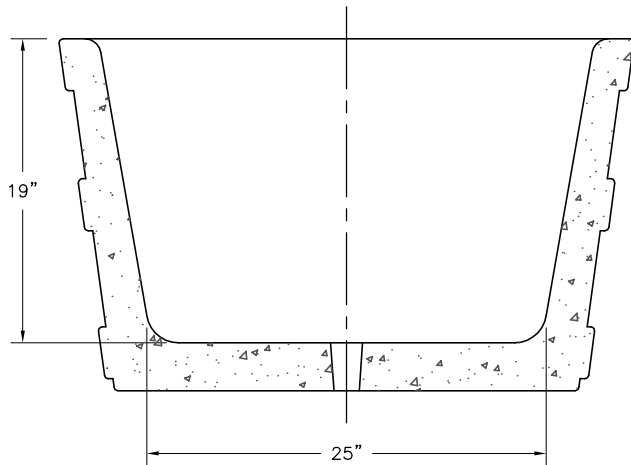

SECTION VIEW

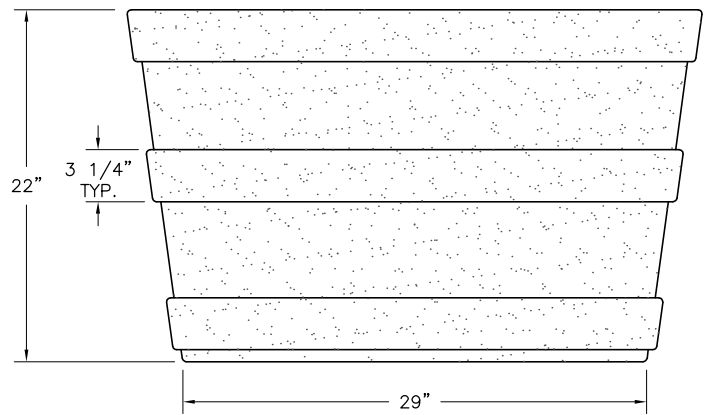

ELEVATION VIEW

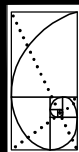

QUICK CRETE
 PRODUCTS CORP.
 731 PARKRIDGE AVE.
 P.O. Box 639
 NORCO, CA 92860
 (951) 737-6240 FAX (951) 737-7032
 WWW.QUICKCRETE.COM

PLAN TYPE:
 PRODUCT:
 PROJECT NAME:

CONSTRUCTION PLAN
 TAOS PLANTER (QR-TS3622P)

DATE: 11/17/98
 SCALE: 1" = 1'

FILE NO. TS3622P
 DRAWN BY: R.M.

SHEET 1 OF 1