

- * INSTALLATION IS REQUIRED BY OTHERS.
- * ALL EDGES TO HAVE 1/4" RADIUS MIN.
- * MANUFACTURING TOLERANCE $\pm 1/4"$.
- * PRODUCT: QR-RIV2621P
- * QUANTITY: _____
- * CONCRETE COLOR: _____
- * CONCRETE TEXTURE: _____
- * SEALER: STD. GLOSS SEALER
- * STD. 2"DIA. DRAIN HOLE
- * INCLUDE INTERIOR WATER SEALANT
- * LITE CRETE ONLY
- * STD. COLOR OPTIONS
- * TEXTURE AVAILABLE IN T1-SMOOTH OR
T9-SANDSTONE ONLY

APROX. WT. 134 LBS.
(CUSTOMER TO OFFLOAD IF OVER 8000 Lbs.)

Authorized Signature _____ Date _____
By signing above or stamping this drawing "approved" or
"no exception taken" authorization is given to Quick Crete
to produce this drawing as shown within a 1/4" tolerance.

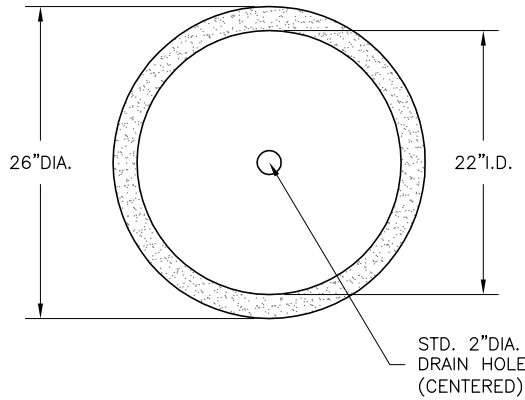

PLAN VIEW

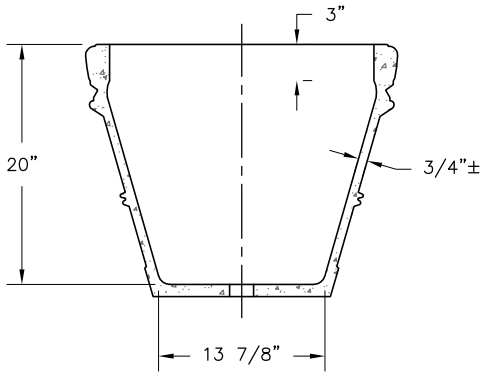

SECTION VIEW

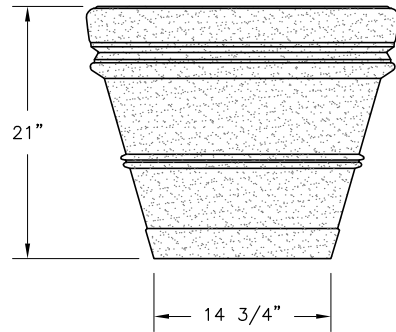

ELEVATION VIEW

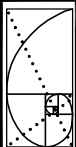

QUICK CRETE
PRODUCTS CORP.
731 PARKRIDGE AVE.
P.O. BOX 639
NORCO, CA 92860
(909) 737-6240 FAX (909) 737-7032
WWW.QUICKCRETE.COM

PLAN TYPE:
PRODUCT:
PROJECT NAME:

CONSTRUCTION PLAN
RIVIERA PLANTER (QR-RIV2621P)

DATE:
07/25/07
SCALE:
3/4" = 1'

FILE NO.
QRRIV2621P
DRAWN BY:
R.M.

SHEET
1
OF
1