

- * INSTALLATION IS REQUIRED BY OTHERS.
- * ALL EDGES TO HAVE 1/4" RADIUS MIN.
- * MANUFACTURING TOLERANCE $\pm 1/4"$.
- * PRODUCT: QS-C04842P
- * QUANTITY: _____
- * CONCRETE COLOR: _____
- * CONCRETE TEXTURE: _____
- * SEALER: STANDARD GLOSS SEALER
- * STD. 2"DIA. DRAIN HOLE
- * INCLUDES INTERIOR WATER SEALANT
- * STD. COLOR & TEXTURE OPTIONS

APROX. WT. 1,895 LBS.
 (CUSTOMER TO OFFLOAD IF OVER 8000 Lbs.)

Authorized Signature _____ Date _____
 By signing above or stamping this drawing "approved" or
 "no exception taken" authorization is given to Quick Crete
 to produce this drawing as shown within a 1/4" tolerance.

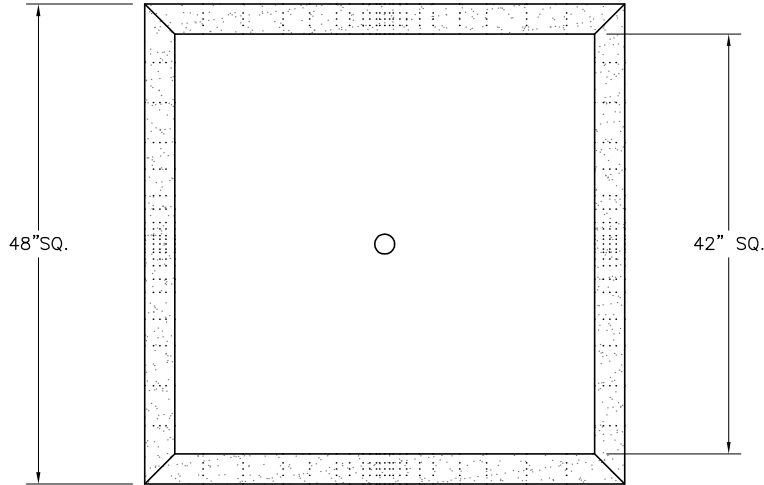

PLAN VIEW

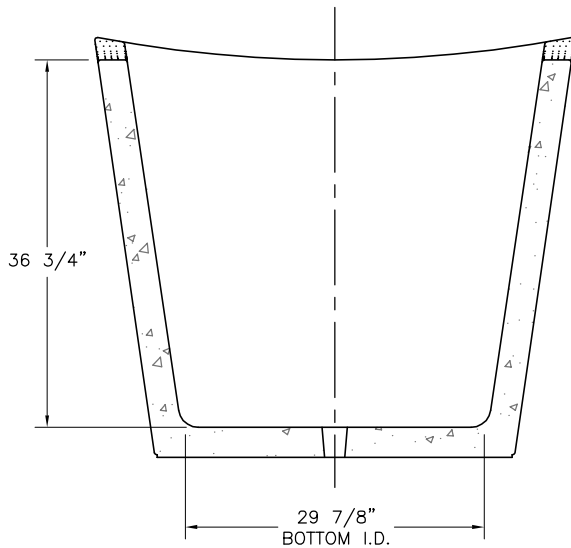

SECTION VIEW

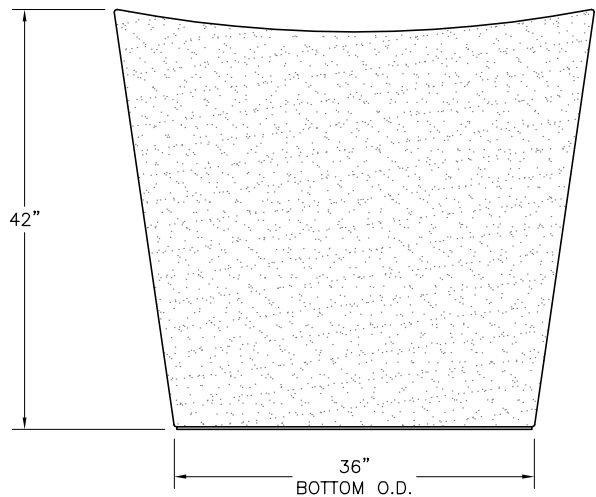

ELEVATION VIEW



QUICK CRETE
 PRODUCTS CORP.
 731 PARKRIDGE AVE.
 P.O. BOX 639
 NORCO, CA 92860
 (951) 737-6240 FAX (951) 737-7032
 WWW.QUICKCRETE.COM

PLAN TYPE:
 PRODUCT:
 PROJECT NAME:

CONSTRUCTION PLAN
 COMPOUND STYLE PLANTER (QS-C04842P)

DATE:
 9/25/06
 SCALE:
 5/8" = 1'

FILE NO.
 QS C04842P
 DRAWN BY:
 R.M.

SHEET
 1
 OF
 1